



ПвЭБВ-6 3x150 **ТУ У 31.3-00214534-017-2003**

Three-core power cables with copper conductors, with XLPE, steel-tape armoured, with PVC compound outer sheath

For the cable of this mark correspond the foreign-made analogues:
2XSEYBY (DE) • Cu/SC/XLPE/SC/CuT/STA/PVC (GB) • ПвБВ (RU)
Technical cable requirements correspond to IEC 60502-2

Cables are used for laying:

- *in places, where mechanical impacts on cable are possible, except tensile forces*
- *in premises, tunnels, ducts, mines, dry soil and outdoor under shelter*
- *single laying*

It is possible to manufacture cables with an integrated fiber-optic module.

Order entry example:

ПвЭБВ-6 3x150/25 (OM) ТУ У 31.3-00214534-017-2003

In conjunction with the DTS system, the integrated fiber-optic module can act as a distributed cable line temperature sensor.

It is possible to manufacture cable with sealed conductors.

Order entry example:

ПвЭБВ-6 3x150/25 (r) ТУ У 31.3-00214534-017-2003

Fire safety code in accordance with ДСТУ 4809:2007: ПБ100000000

Products of this mark meet the requirements:

- *single wire cable flame retardance*



ПВЭБВ-6 3x150 TY Y 31.3-00214534-017-2003

Three-core power cables with copper conductors, with XLPE, steel-tape armoured, with PVC compound outer sheath

TECHNICAL SPECIFICATIONS

Rated voltage	kV	6
Maximum voltage	kV	7.2
Number and rated area of conductors	mm ²	3 x 150
Insulation thickness	mm	2.5
Minimum screen cross-section	mm ²	25
Permissible short circuit current across the screen of minimum cross-section	kA	5.1
Maximum permissible short-circuit current in core	kA	21.5
Permissible continuous current rating *		
• by aerial laying	A	397
• by burial	A	332
Partial discharge factor for rated voltage, not more than	pC	6
Maximum permissible conductor temperature		
• Continuous	°C	+90
• in emergency operation	°C	+130
• at short circuit	°C	+250
Operating temperature range (in climate version NF)	°C	-50 ... +50
Operating temperature range (in climate version T)	°C	-25 ... +65
Minimum bending radius by laying	mm	1024
Rated outer diameter of the cable (for reference) **	mm	64
Cable weight (approximate)	kg/km	8210
Rated factory cable length and gross weight of the delivery on the drums	m, t	# 22УД-60: 450 • 4.6 # 25УД-90: 771 • 7.9

Notes:

When ordering it is necessary to agree the factory length of the product with the manufacturer

* Long permissible current loads are calculated for the following conditions: conductor temperature 90 °C, air temperature 30 °C, soil temperature 20 °C, load factor 1.0, thermal resistivity of soil 1.5 °K·m/W, laying depth in the ground 0.8 m, shields are grounded at both ends of the line

** The external diameter may differ from the rated up to ± 10 %



ПВЭБВ-6 3x150
ТУ У 31.3-00214534-017-2003

Three-core power cables with copper conductors, with XLPE, steel-tape armoured, with PVC compound outer sheath

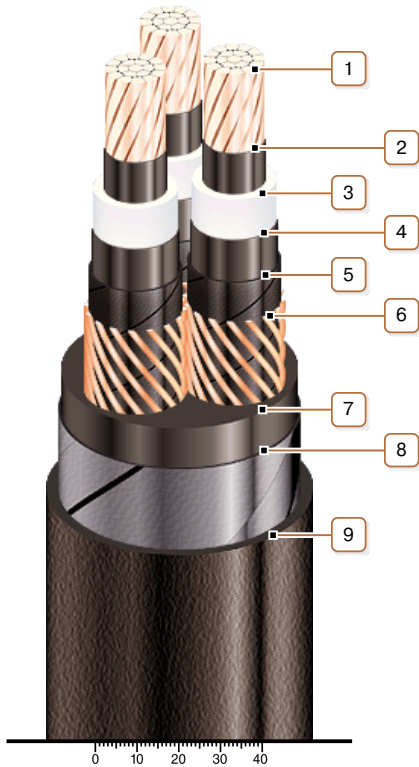

CONSTRUCTION

1. Copper multiwire compact conductor

Note: It is possible to manufacture cable with sealed conductors.

2. Inner extruded semiconducting layer

3. XLPE insulation

4. Outer extruded semiconducting layer

5. Lapping layer of semiconductive swellable tape

6. Copper screen

7. Extruded filling of PVC compound

8. Double galvanized steel-tape armour

9. PVC compound outer sheath

Note: Conductor twisting is not illustrated