



## **ПвЭБВ-6 3x120** **ТУ У 31.3-00214534-017-2003**

Three-core power cables with copper conductors, with XLPE, steel-tape armoured, with PVC compound outer sheath

For the cable of this mark correspond the foreign-made analogues:  
2XSEYBY (DE) • Cu/SC/XLPE/SC/CuT/STA/PVC (GB) • ПвБВ (RU)  
Technical cable requirements correspond to IEC 60502-2

Cables are used for laying:

- *in places, where mechanical impacts on cable are possible, except tensile forces*
- *in premises, tunnels, ducts, mines, dry soil and outdoor under shelter*
- *single laying*

It is possible to manufacture cables with an integrated fiber-optic module.

Order entry example:

ПвЭБВ-6 3x120/16 (OM) ТУ У 31.3-00214534-017-2003

In conjunction with the DTS system, the integrated fiber-optic module can act as a distributed cable line temperature sensor.

It is possible to manufacture cable with sealed conductors.

Order entry example:

ПвЭБВ-6 3x120/16 (r) ТУ У 31.3-00214534-017-2003

Fire safety code in accordance with ДСТУ 4809:2007: ПБ100000000

Products of this mark meet the requirements:

- *single wire cable flame retardance*



## **ПВЭБВ-6 3x120** **TY Y 31.3-00214534-017-2003**

Three-core power cables with copper conductors, with XLPE, steel-tape armoured, with PVC compound outer sheath

### **TECHNICAL SPECIFICATIONS**

Rated voltage	kV	6
Maximum voltage	kV	7.2
Number and rated area of conductors	mm <sup>2</sup>	3 x 120
Insulation thickness	mm	2.5
Minimum screen cross-section	mm <sup>2</sup>	16
Permissible short circuit current across the screen of minimum cross-section	kA	3.3
Maximum permissible short-circuit current in core	kA	17.2
Permissible continuous current rating *		
• by aerial laying	A	352
• by burial	A	298
Partial discharge factor for rated voltage, not more than	pC	6
Maximum permissible conductor temperature		
• Continuous	°C	+90
• in emergency operation	°C	+130
• at short circuit	°C	+250
Operating temperature range (in climate version NF)	°C	-50 ... +50
Operating temperature range (in climate version T)	°C	-25 ... +65
Minimum bending radius by laying	mm	976
Rated outer diameter of the cable (for reference) **	mm	61
Cable weight (approximate)	kg/km	7150
Rated factory cable length and gross weight of the delivery on the drums	m, t	# 22УД-60: 475 • 4.3 # 25УД-90: 808 • 7.3

**Notes:**

When ordering it is necessary to agree the factory length of the product with the manufacturer

\* Long permissible current loads are calculated for the following conditions: conductor temperature 90 °C, air temperature 30 °C, soil temperature 20 °C, load factor 1.0, thermal resistivity of soil 1.5 °K·m/W, laying depth in the ground 0.8 m, shields are grounded at both ends of the line

\*\* The external diameter may differ from the rated up to ± 10 %



**ПВЭБВ-6 3x120**  
**ТУ У 31.3-00214534-017-2003**

Three-core power cables with copper conductors, with XLPE, steel-tape armoured, with PVC compound outer sheath

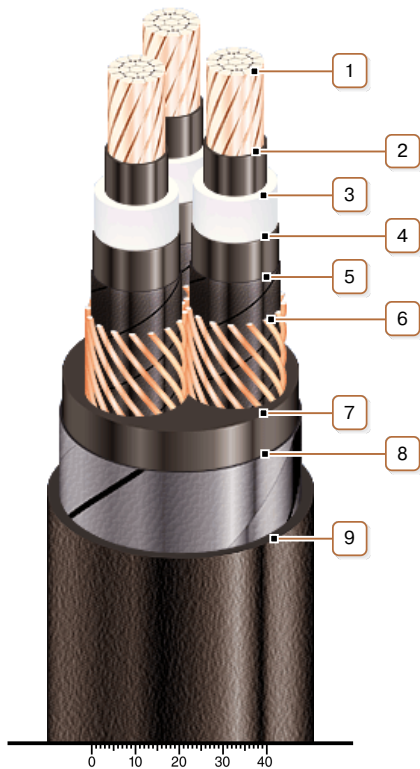

### CONSTRUCTION

**1. Copper multiwire compact conductor**

*Note: It is possible to manufacture cable with sealed conductors.*

**2. Inner extruded semiconducting layer**

**3. XLPE insulation**

**4. Outer extruded semiconducting layer**

**5. Lapping layer of semiconductive swellable tape**

**6. Copper screen**

**7. Extruded filling of PVC compound**

**8. Double galvanized steel-tape armour**

**9. PVC compound outer sheath**

*Note: Conductor twisting is not illustrated*