



## **ПвЭогаП-10 3x70 ТУ У 31.3-00214534-017-2003**

Three-core power cables with copper conductors, with XLPE, collective screen, with longitudinal and transverse sealing and polyethylene outer sheath

---

Technical cable requirements correspond to IEC 60502-2

Cables are used for laying:

- *in soil (trenches)*
- *in damp, partially flooded premises*
- *in ground with high humidity*
- *in non-navigable waters*
- *in the air, including cable structures, if provided the additional fire protection*

---

It is possible to manufacture cables with extruded semiconductor layer along outer sheath.

Order entry example:

ПвЭогаП-П-10 3x70/35 ТУ У 31.3-00214534-017-2003

An extruded semiconductor layer along outer sheath ensures the correct testing of cable line with sections of underground laying in polymer pipes.

---

It is possible to manufacture cables with an integrated fiber-optic module.

Order entry example:

ПвЭогаП-10 3x70/35 (OM) ТУ У 31.3-00214534-017-2003

In conjunction with the DTS system, the integrated fiber-optic module can act as a distributed cable line temperature sensor.

---

It is possible to manufacture cable with sealed conductors.

Order entry example:

ПвЭогаП-10 3x70/35 (r) ТУ У 31.3-00214534-017-2003

---



## ПвЭогаП-10 3x70 ТУ У 31.3-00214534-017-2003

Three-core power cables with copper conductors, with XLPE, collective screen, with longitudinal and transverse sealing and polyethylene outer sheath

### TECHNICAL SPECIFICATIONS

|  |                 |  |
|--|-----------------|--|
| Rated voltage  | kV              | 10   |
| Maximum voltage  | kV              | 12   |
| Number and rated area of conductors  | mm <sup>2</sup> | 3 x 70   |
| Insulation thickness   | mm              | 3.4  |
| Minimum screen cross-section   | mm <sup>2</sup> | 35   |
| Permissible short circuit current across the screen of minimum cross-section | kA              | 7.1  |
| Maximum permissible short-circuit current in core                            | kA              | 10   |
| Permissible continuous current rating *                                      |                 |  |
| • by aerial laying   | A               | 253  |
| • by burial  | A               | 221  |
| Partial discharge factor for rated voltage, not more than                    | pC              | 6  |
| Maximum permissible conductor temperature                                    |                 |  |
| • Continuous   | °C              | +90  |
| • in emergency operation   | °C              | +130   |
| • at short circuit   | °C              | +250   |
| Operating temperature range  | °C              | -60 ... +50  |
| Minimum bending radius by laying   | mm              | 928  |
| Rated outer diameter of the cable (for reference) **                         | mm              | 58   |
| Cable weight (approximate)   | kg/km           | 4290   |
| Rated factory cable length and gross weight of the delivery on the drums *** | m, t            | # 18аУД-40: 423 • 2.4<br># 20аУД-60: 526 • 3.0<br># 25УД-90: 838 • 5.2 |

#### Notes:

When ordering it is necessary to agree the factory length of the product with the manufacturer

\* Long permissible current loads are calculated for the following conditions: conductor temperature 90 °C, air temperature 30 °C, soil temperature 20 °C, load factor 1.0, thermal resistivity of soil 1.5 °K·m/W, laying depth in the ground 0.8 m, shields are grounded at both ends of the line

\*\* The external diameter may differ from the rated up to ± 10 %

\*\*\* Отклонение фактической массы брутто от указанного значения может составлять ± 7 %



**ПвЭогаП-10 3x70**  
**ТУ У 31.3-00214534-017-2003**

Three-core power cables with copper conductors, with XLPE, collective screen, with longitudinal and transverse sealing and polyethylene outer sheath

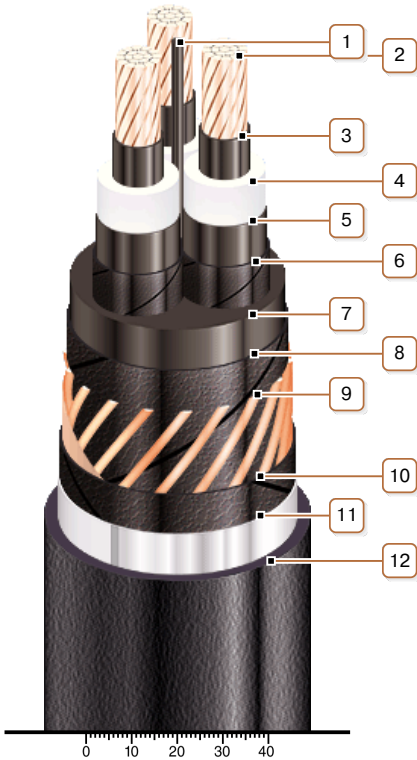

**CONSTRUCTION**

1. Central polyethylene bundle
2. Copper multiwire compact conductor  
*Note: It is possible to manufacture cable with sealed conductors.*
3. Inner extruded semiconducting layer
4. XLPE insulation
5. Outer extruded semiconducting layer
6. Lapping layer of semiconductive swellable tape
7. Extruded filling of semiconducting polyethylene
8. Lapping layer of semiconductive swellable tape
9. Copper screen
10. Lapping layer of semiconductive swellable tape
11. Alumopolymer tape
12. Outer sheath of polyethylene or polyethylene copolymer  
*Note: It is possible to manufacture cable with extruded semiconductor layer along outer sheath*

*Note: Conductor twisting is not illustrated*