



ПвЭогВнгд-30 3x185 ТУ У 31.3-00214534-017-2003

Three-core power cables with copper conductors, flame-retardant, with XLPE, collective screen, with longitudinal sealing and PVC compound outer sheath and with low smoke and gas emission

Technical cable requirements correspond to IEC 60502-2

Cables are used for laying:

- *in premises, tunnels, ducts, mines, dry soil and outdoor under shelter*
- *in bunches*
- *at sites, where low smoke and gas emission are required (NPP, subway, large industrial facilities, high-rise buildings, etc.)*

It is possible to manufacture cables with an integrated fiber-optic module.

Order entry example:

ПвЭогВнгд-30 3x185/70 (ОМ) ТУ У 31.3-00214534-017-2003

In conjunction with the DTS system, the integrated fiber-optic module can act as a distributed cable line temperature sensor.

It is possible to manufacture cable with sealed conductors.

Order entry example:

ПвЭогВнгд-30 3x185/70 (Г) ТУ У 31.3-00214534-017-2003

Fire safety code in accordance with ДСТУ 4809:2007: ПБ132121000

Products of this mark meet the requirements:

- *single wire cable flame retardance*
- *bunched cable flame retardance category B*
- *toxicity class Tk2 of the combustion products of nonmetallic elements (toxicity index from 40 up to 120 g/m³)*
- *class ДТк1 on smoke-forming ability by smouldering of non-metallic elements (coefficient of smoke formation from 50 to 500 m²/kg)*
- *class ДПк2 on smoke-forming ability by combustion (minimum luminous flux more than 60 %)*
- *corrosive class Кк1 of combustion products of non-metallic elements (the number of halogen hydrides less than 150 mg/g, pH less than 4.3, specific conductivity more than 10 μS/mm)*



ПвЭогВнгд-30 3x185 ТУ У 31.3-00214534-017-2003

Three-core power cables with copper conductors, flame-retardant, with XLPE, collective screen, with longitudinal sealing and PVC compound outer sheath and with low smoke and gas emission

TECHNICAL SPECIFICATIONS

Rated voltage	kV	30
Maximum voltage	kV	36
Number and rated area of conductors	mm ²	3 x 185
Insulation thickness	mm	8
Minimum screen cross-section	mm ²	70
Permissible short circuit current across the screen of minimum cross-section	kA	14.2
Maximum permissible short-circuit current in core	kA	26.5
Permissible continuous current rating *		
• <i>by aerial laying</i>	A	455
• <i>by burial</i>	A	377
Partial discharge factor for rated voltage, not more than	pC	6
Maximum permissible conductor temperature		
• <i>Continuous</i>	°C	+90
• <i>in emergency operation</i>	°C	+130
• <i>at short circuit</i>	°C	+250
Operating temperature range (in climate version NF)	°C	-50 ... +50
Operating temperature range (in climate version T)	°C	-25 ... +65
Minimum bending radius by laying	mm	1504
Rated outer diameter of the cable (for reference) **	mm	94
Cable weight (approximate)	kg/km	11910
Rated factory cable length and gross weight of the delivery on the drums	m, t	# 25УД-90: 283 • 4.9 # 26УД-100: 433 • 7.0 # 30УД-130: ***600 • 10.0

Notes:

When ordering it is necessary to agree the factory length of the product with the manufacturer

* Long permissible current loads are calculated for the following conditions: conductor temperature 90 °C, air temperature 30 °C, soil temperature 20 °C, load factor 1.0, thermal resistivity of soil 1.5 °K·m/W, laying depth in the ground 0.8 m, shields are grounded at both ends of the line

** The external diameter may differ from the rated up to ± 10 %

*** Option delivery on not full drum



ПвЭогВнгд-30 3x185 ТУ У 31.3-00214534-017-2003

Three-core power cables with copper conductors, flame-retardant, with XLPE, collective screen, with longitudinal sealing and PVC compound outer sheath and with low smoke and gas emission

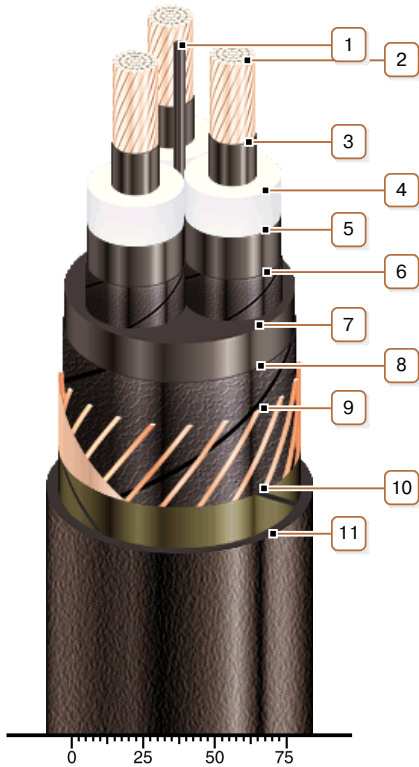

CONSTRUCTION

1. Central polyethylene bundle
2. Copper multiwire compact conductor
3. Inner extruded semiconducting layer
4. XLPE insulation
5. Outer extruded semiconducting layer
6. Lapping layer of semiconductive swellable tape
7. Extruded filling of semiconducting polyethylene
8. Lapping layer of semiconductive swellable tape
9. Copper screen
10. Lapping layer of glass tape
11. Low fire-risk PVC compound outer sheath

Note: Conductor twisting is not illustrated