



АПвАПу-35 1x300 **ТУ У 27.3-00214534-092:2016**

Single-core power cables with aluminium conductors, XLPE-insulated, aluminium sheathed, with reinforced outer sheath of polyethylene

Technical cable requirements correspond to IEC 60502-2

Cables are used for laying:

- *in places, where small mechanical impacts on cable are possible, including tensile forces*
- *in soil (trenches)*
- *in damp, partially flooded premises*
- *on difficult route sections, according to the unique specification*
- *in the air, including cable structures, if provided the additional fire protection*

It is possible to manufacture cables with extruded semiconductor layer along outer sheath.

Order entry example:

АПвАПу-П-35 1x300/25 ТУ У 27.3-00214534-092:2016

An extruded semiconductor layer along outer sheath ensures the correct testing of cable line with sections of underground laying in polymer pipes.

It is possible to manufacture cables with an integrated fiber-optic module.

Order entry example:

АПвАПу-35 1x300/25 (OM) ТУ У 27.3-00214534-092:2016

In conjunction with the DTS system, the integrated fiber-optic module can act as a distributed cable line temperature sensor.

Cables with copper screen can also be manufactured

It is possible to manufacture cable with sealed conductor.

Order entry example:

АПвАПу-35 1x300/25 (r) ТУ У 27.3-00214534-092:2016



АПвАПу-35 1x300 ТУ У 27.3-00214534-092:2016

Single-core power cables with aluminium conductors, XLPE-insulated, aluminium sheathed, with reinforced outer sheath of polyethylene

TECHNICAL SPECIFICATIONS

Rated voltage	kV	35
Maximum voltage	kV	42
Number and rated area of conductors	mm ²	1 x 300
Insulation thickness	mm	8.6
Sheath thickness	mm	1.8
Permissible short circuit current across the screen	kA	20.30
Maximum permissible short-circuit current in core	kA	28.2
Permissible continuous current rating *		
• by aerial laying in trefoil formation	A	577
• by aerial flat laying	A	677
• by burial in trefoil formation	A	414
• by burial flat	A	419
Partial discharge factor for rated voltage, not more than	pC	6
Maximum permissible conductor temperature		
• Continuous	°C	+90
• in emergency operation	°C	+130
• at short circuit	°C	+250
Operating temperature range	°C	-60 ... +50
Minimum bending radius by laying	mm	1275
Rated outer diameter of the cable (for reference) **	mm	51
Cable weight (approximate)	kg/km	3030
Rated factory cable length and gross weight of the delivery on the drums	m, t	# 22УД-60: 661 • 2.9 # 25УД-90: 1108 • 4.9

Notes:

When ordering it is necessary to agree the factory length of the product with the manufacturer

* Long permissible current loads are calculated for the following conditions: conductor temperature 90 °C, air temperature 30 °C, soil temperature 20 °C, thermal resistivity of soil 1.5 °K·m/W, laying depth in the soil 0.8 m, while laying in flat formation the distance between cables in clear is equal to the cable diameter, while laying in trefoil formation cables are laid side by side, shields are earthed on both ends of the line

** The external diameter may differ from the rated up to ± 10 %



АПвАПу-35 1x300 ТУ У 27.3-00214534-092:2016

Single-core power cables with aluminium conductors, XLPE-insulated, aluminium sheathed, with reinforced outer sheath of polyethylene

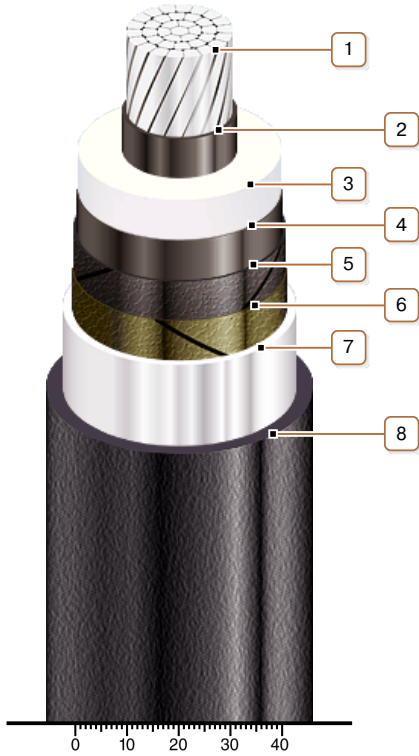

CONSTRUCTION

1. Aluminium multiwire compacted conductor

Note: It is possible to manufacture cable with sealed conductor.

2. Inner extruded semiconducting layer

3. XLPE insulation

4. Outer extruded semiconducting layer

5. Lapping layer of semiconductive swellable tape

6. Lapping layer of semiconductive tape

7. Aluminium sheath

8. Strengthened polyethylene outer sheath

Note: It is possible to manufacture cable with extruded semiconductor layer along outer sheath

Note: Cables with copper screen can also be manufactured