



## **АПВЭАкП-15 1x630** **ТУ У 31.3-00214534-017-2003**

Single-core power cables with aluminium conductor, with XLPE, aluminium-wire armoured, with polyethylene outer sheath

---

For the cable of this mark correspond the foreign-made analogues:

Al/XLPE/CWS/PE/AWA/MDPE (GB) • XHAKXSAx (PL)

Due to non-magnetic armour, cables operate at AC

Technical cable requirements correspond to IEC 60502-2

---

Cables are used for laying:

- *in places, where small mechanical impacts on cable are possible, including tensile forces*
  - *in soil (trenches)*
  - *in the air, including cable structures, if provided the additional fire protection*
- 

It is possible to manufacture cables with extruded semiconductor layer along outer sheath.

Order entry example:

АПВЭАкП-П-15 1x630/35 ТУ У 31.3-00214534-017-2003

An extruded semiconductor layer along outer sheath ensures the correct testing of cable line with sections of underground laying in polymer pipes.

---

It is possible to manufacture cables with an integrated fiber-optic module.

Order entry example:

АПВЭАкП-15 1x630/35 (OM) ТУ У 31.3-00214534-017-2003

In conjunction with the DTS system, the integrated fiber-optic module can act as a distributed cable line temperature sensor.

---

It is possible to manufacture cable with sealed conductor.

Order entry example:

АПВЭАкП-15 1x630/35 (r) ТУ У 31.3-00214534-017-2003

---



## АПВЭАкП-15 1x630 ТУ У 31.3-00214534-017-2003

Single-core power cables with aluminium conductor, with XLPE, aluminium-wire armoured, with polyethylene outer sheath

### TECHNICAL SPECIFICATIONS

|  |                 |  |
|--|-----------------|--|
| Rated voltage  | kV              | 15   |
| Maximum voltage  | kV              | 17.5   |
| Number and rated area of conductors  | mm <sup>2</sup> | 1 x 630                                      |
| Insulation thickness   | mm              | 4.5  |
| Minimum screen cross-section   | mm <sup>2</sup> | 35   |
| Permissible short circuit current across the screen of minimum cross-section | kA              | 7.1  |
| Maximum permissible short-circuit current in core                            | kA              | 59   |
| Permissible continuous current rating *                                      |                 |  |
| • by aerial laying in trefoil formation                                      | A               | 907  |
| • by aerial flat laying  | A               | 1001   |
| • by burial in trefoil formation   | A               | 593  |
| • by burial flat   | A               | 584  |
| Partial discharge factor for rated voltage, not more than                    | pC              | 6  |
| Maximum permissible conductor temperature                                    |                 |  |
| • Continuous   | °C              | +90  |
| • in emergency operation   | °C              | +130   |
| • at short circuit   | °C              | +250   |
| Operating temperature range  | °C              | -60 ... +50                                  |
| Minimum bending radius by laying   | mm              | 960  |
| Rated outer diameter of the cable (for reference) **                         | mm              | 60   |
| Cable weight (approximate)   | kg/km           | 4390   |
| Rated factory cable length and gross weight of the delivery on the drums     | m, t            | # 22УД-60: 475 • 3.0<br># 25УД-90: 838 • 5.2 |

#### Notes:

When ordering it is necessary to agree the factory length of the product with the manufacturer

\* Long permissible current loads are calculated for the following conditions: conductor temperature 90 °C, air temperature 30 °C, soil temperature 20 °C, thermal resistivity of soil 1.5 °K·m/W, laying depth in the soil 0.8 m, while laying in flat formation the distance between cables in clear is equal to the cable diameter, while laying in trefoil formation cables are laid side by side, shields are earthed on both ends of the line

\*\* The external diameter may differ from the rated up to ± 10 %



## АПВЭАкП-15 1x630 ТУ У 31.3-00214534-017-2003

Single-core power cables with aluminium conductor, with XLPE, aluminium-wire armoured, with polyethylene outer sheath

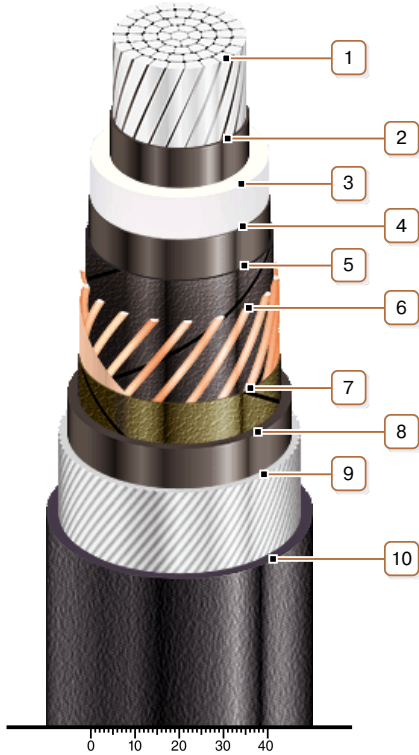

### CONSTRUCTION

**1. Aluminium multiwire compacted conductor**

*Note: It is possible to manufacture cable with sealed conductor.*

**2. Inner extruded semiconducting layer**

**3. XLPE insulation**

**4. Outer extruded semiconducting layer**

**5. Lapping layer of semiconductive swellable tape**

**6. Copper screen**

**7. Lapping layer of nonwoven cloth tape**

**8. Extruded bedding of polyethylene**

**9. Aluminium-wire armour**

**10. Outer sheath of polyethylene or polyethylene copolymer**

*Note: It is possible to manufacture cable with extruded semiconductor layer along outer sheath*