



АПВЭКПγ-30 3x95 ТУ У 31.3-00214534-017-2003

Three-core power cables with aluminium conductors, with XLPE, steel-wire armoured, with strengthened polyethylene outer sheath

Technical cable requirements correspond to IEC 60502-2

Cables are used for laying:

- *in places, where mechanical impacts on cable are possible, including tensile forces*
- *in soil (trenches)*
- *on difficult route sections, according to the unique specification*
- *in the air, including cable structures, if provided the additional fire protection*

It is possible to manufacture cables with extruded semiconductor layer along outer sheath.

Order entry example:

АПВЭКПγ-П-30 3x95/16 ТУ У 31.3-00214534-017-2003

An extruded semiconductor layer along outer sheath ensures the correct testing of cable line with sections of underground laying in polymer pipes.

It is possible to manufacture cables with an integrated fiber-optic module.

Order entry example:

АПВЭКПγ-30 3x95/16 (OM) ТУ У 31.3-00214534-017-2003

In conjunction with the DTS system, the integrated fiber-optic module can act as a distributed cable line temperature sensor.

It is possible to manufacture cable with sealed conductors.

Order entry example:

АПВЭКПγ-30 3x95/16 (r) ТУ У 31.3-00214534-017-2003



АПвЭКПы-30 3x95 ТУ У 31.3-00214534-017-2003

Three-core power cables with aluminium conductors, with XLPE, steel-wire armoured, with strengthened polyethylene outer sheath

TECHNICAL SPECIFICATIONS

Rated voltage	kV	30
Maximum voltage	kV	36
Number and rated area of conductors	mm ²	3 x 95
Insulation thickness	mm	8
Minimum screen cross-section	mm ²	16
Permissible short circuit current across the screen of minimum cross-section	kA	3.3
Maximum permissible short-circuit current in core	kA	8.9
Permissible continuous current rating *		
• by aerial laying	A	238
• by burial	A	204
Partial discharge factor for rated voltage, not more than	pC	6
Maximum permissible conductor temperature		
• Continuous	°C	+90
• in emergency operation	°C	+130
• at short circuit	°C	+250
Operating temperature range	°C	-60 ... +50
Minimum bending radius by laying	mm	1424
Rated outer diameter of the cable (for reference) **	mm	89
Cable weight (approximate)	kg/km	10950
Rated factory cable length and gross weight of the delivery on the drums ***	m, t	# 25УД-90: 396 • 5.9 # 26УД-100: 457 • 6.8 # 30УД-130: **** 652 • 10.0

Notes:

When ordering it is necessary to agree the factory length of the product with the manufacturer

* Long permissible current loads are calculated for the following conditions: conductor temperature 90 °C, air temperature 30 °C, soil temperature 20 °C, load factor 1.0, thermal resistivity of soil 1.5 °K·m/W, laying depth in the ground 0.8 m, shields are grounded at both ends of the line

** The external diameter may differ from the rated up to ± 10 %

*** Отклонение фактической массы брутто от указанного значения может составлять ± 7 %

**** Option delivery on not full drum



АПвЭКПы-30 3x95 ТУ У 31.3-00214534-017-2003

Three-core power cables with aluminium conductors, with XLPE, steel-wire armoured, with strengthened polyethylene outer sheath

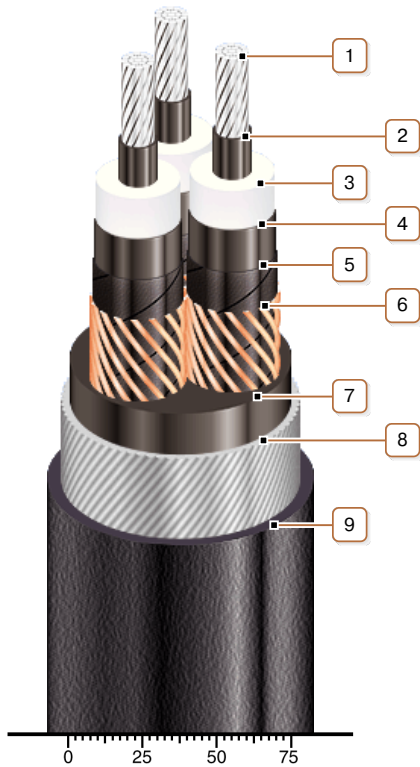

CONSTRUCTION

1. Aluminium multiwire compacted conductor

Notes:

- It is possible to manufacture cable with a single-wire conductor
- It is possible to manufacture cable with sealed conductors.

2. Inner extruded semiconducting layer

3. XLPE insulation

4. Outer extruded semiconducting layer

5. Lapping layer of semiconductive swellable tape

6. Copper screen

7. Extruded filling of PVC compound

8. Round galvanized steel-wire armour

9. Strengthened polyethylene outer sheath

Note: It is possible to manufacture cable with extruded semiconductor layer along outer sheath

Note: Conductor twisting is not illustrated