



## **АПВЭКВнг-20 3x95 ТУ У 31.3-00214534-017-2003**

Three-core power cables with aluminium conductors, flame-retardant, with XLPE, steel-wire armoured, with PVC compound outer sheath

---

Technical cable requirements correspond to IEC 60502-2

Cables are used for laying:

- *in places, where mechanical impacts on cable are possible, including tensile forces*
- *in premises, tunnels, ducts, mines, dry soil and outdoor under shelter*
- *in bunches*

---

It is possible to manufacture cables with an integrated fiber-optic module.

Order entry example:

АПВЭКВнг-20 3x95/16 (OM) ТУ У 31.3-00214534-017-2003

In conjunction with the DTS system, the integrated fiber-optic module can act as a distributed cable line temperature sensor.

---

It is possible to manufacture cable with sealed conductors.

Order entry example:

АПВЭКВнг-20 3x95/16 (r) ТУ У 31.3-00214534-017-2003

---

Fire safety code in accordance with ДСТУ 4809:2007: ПБ120000000

Products of this mark meet the requirements:

- *single wire cable flame retardance*
- *bunched cable flame retardance category A*



## АПвЭКВнг-20 3x95 ТУ У 31.3-00214534-017-2003

Three-core power cables with aluminium conductors, flame-retardant, with XLPE, steel-wire armoured, with PVC compound outer sheath

### TECHNICAL SPECIFICATIONS

Rated voltage	kV	20
Maximum voltage	kV	24
Number and rated area of conductors	mm <sup>2</sup>	3 x 95
Insulation thickness	mm	5.5
Minimum screen cross-section	mm <sup>2</sup>	16
Permissible short circuit current across the screen of minimum cross-section	kA	3.3
Maximum permissible short-circuit current in core	kA	8.9
Permissible continuous current rating *		
• by aerial laying	A	238
• by burial	A	204
Partial discharge factor for rated voltage, not more than	pC	6
Maximum permissible conductor temperature		
• Continuous	°C	+90
• in emergency operation	°C	+130
• at short circuit	°C	+250
Operating temperature range (in climate version NF)	°C	-50 ... +50
Operating temperature range (in climate version T)	°C	-25 ... +65
Minimum bending radius by laying	mm	1168
Rated outer diameter of the cable (for reference) **	mm	73
Cable weight (approximate)	kg/km	7690
Rated factory cable length and gross weight of the delivery on the drums	m, t	# 22УД-60: 319 • 3.4 # 25УД-90: 583 • 6.1

#### Notes:

When ordering it is necessary to agree the factory length of the product with the manufacturer

\* Long permissible current loads are calculated for the following conditions: conductor temperature 90 °C, air temperature 30 °C, soil temperature 20 °C, load factor 1.0, thermal resistivity of soil 1.5 °K·m/W, laying depth in the ground 0.8 m, shields are grounded at both ends of the line

\*\* The external diameter may differ from the rated up to ± 10 %



## АПВЭКВнг-20 3x95 ТУ У 31.3-00214534-017-2003

Three-core power cables with aluminium conductors, flame-retardant, with XLPE, steel-wire armoured, with PVC compound outer sheath

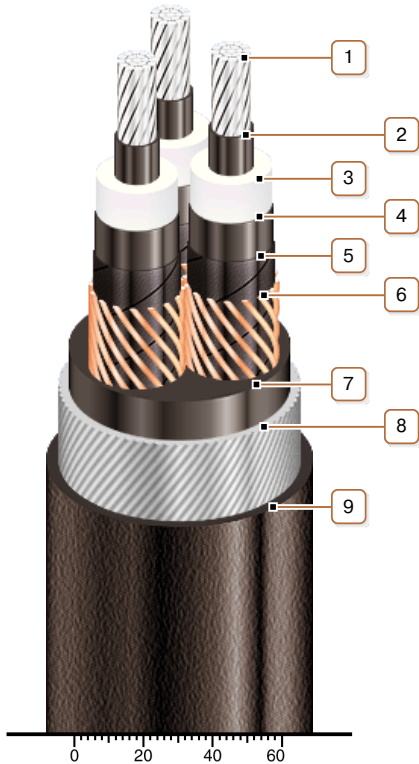

### CONSTRUCTION

#### 1. Aluminium multiwire compacted conductor

Notes:

- It is possible to manufacture cable with a single-wire conductor
- It is possible to manufacture cable with sealed conductors.

#### 2. Inner extruded semiconducting layer

#### 3. XLPE insulation

#### 4. Outer extruded semiconducting layer

#### 5. Lapping layer of semiconductive swellable tape

#### 6. Copper screen

#### 7. Extruded filling of PVC compound

#### 8. Round galvanized steel-wire armour

#### 9. Low flammable PVC compound outer sheath

Note: Conductor twisting is not illustrated