



100107-100010001000



АПвЭгаПу-10 1x1000 **ТУ У 31.3-00214534-017-2003**

Power cables with aluminium conductors, with XLPE, longitudinal and transverse screen sealing and strengthened polyethylene outer sheath

For the cable of this mark correspond the foreign-made analogues:

АПвПу2г (RU)

Technical cable requirements correspond to IEC 60502-2

Cables are used for laying:

- *in soil (trenches)*
 - *in damp, partially flooded premises*
 - *in ground with high humidity*
 - *in non-navigable waters*
 - *on difficult route sections, according to the unique specification*
 - *in the air, including cable structures, if provided the additional fire protection*
-

It is possible to manufacture cable with a segmented conductor

It is possible to manufacture cables with extruded semiconductor layer along outer sheath.

Order entry example:

АПвЭгаПу-П-10 1x1000/70 ТУ У 31.3-00214534-017-2003

An extruded semiconductor layer along outer sheath ensures the correct testing of cable line with sections of underground laying in polymer pipes.

It is possible to manufacture cables with an integrated fiber-optic module.

Order entry example:

АПвЭгаПу-10 1x1000/70 (ОМ) ТУ У 31.3-00214534-017-2003

In conjunction with the DTS system, the integrated fiber-optic module can act as a distributed cable line temperature sensor.

It is possible to manufacture cable with sealed conductor.

Order entry example:

АПвЭгаПу-10 1x1000/70 (г) ТУ У 31.3-00214534-017-2003



АПвЭгаПу-10 1x1000 ТУ У 31.3-00214534-017-2003

Power cables with aluminium conductors, with XLPE, longitudinal and transverse screen sealing and strengthened polyethylene outer sheath

TECHNICAL SPECIFICATIONS

Rated voltage	kV	10
Maximum voltage	kV	12
Number and rated area of conductors	mm ²	1 x 1000
Insulation thickness	mm	3.4
Minimum screen cross-section	mm ²	70
Permissible short circuit current across the screen of minimum cross-section	kA	14.2
Maximum permissible short-circuit current in core	kA	94
Permissible continuous current rating *		
• by aerial laying in trefoil formation	A	1214
• by aerial flat laying	A	1315
• by burial in trefoil formation	A	736
• by burial flat	A	717
Partial discharge factor for rated voltage, not more than	pC	6
Maximum permissible conductor temperature		
• Continuous	°C	+90
• in emergency operation	°C	+130
• at short circuit	°C	+250
Operating temperature range	°C	-60 ... +50
Minimum bending radius by laying	mm	960
Rated outer diameter of the cable (for reference) **	mm	60
Cable weight (approximate)	kg/km	4640
Rated factory cable length and gross weight of the delivery on the drums ***	m, t	# 22УД-60: 475 • 3.1 # 25УД-90: 838 • 5.5

Notes:

When ordering it is necessary to agree the factory length of the product with the manufacturer

* Long permissible current loads are calculated for the following conditions: conductor temperature 90 °C, air temperature 30 °C, soil temperature 20 °C, thermal resistivity of soil 1.5 °K·m/W, laying depth in the soil 0.8 m, while laying in flat formation the distance between cables in clear is equal to the cable diameter, while laying in trefoil formation cables are laid side by side, shields are earthed on both ends of the line

** The external diameter may differ from the rated up to ± 10 %

*** Отклонение фактической массы брутто от указанного значения может составлять ± 7 %



АПвЭгаПу-10 1x1000 ТУ У 31.3-00214534-017-2003

Power cables with aluminium conductors, with XLPE, longitudinal and transverse screen sealing and strengthened polyethylene outer sheath

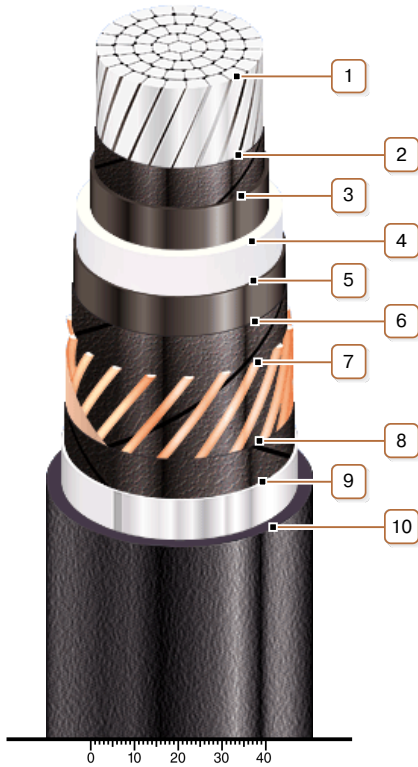

CONSTRUCTION

1. Aluminium multiwire compacted conductor

Notes:

- It is possible to manufacture cable with a segmented conductor
- It is possible to manufacture cable with sealed conductor.

2. Lapping layer of semiconductive swellable tape

3. Inner extruded semiconducting layer

4. XLPE insulation

5. Outer extruded semiconducting layer

6. Lapping layer of semiconductive swellable tape

7. Copper screen

8. Lapping layer of semiconductive swellable tape

9. Alumopolymer tape

10. Strengthened polyethylene outer sheath

Note: It is possible to manufacture cable with extruded semiconductor layer along outer sheath