

## **АПвЭгП-20 1x1000** **ТУ У 31.3-00214534-017-2003**

Power cables with aluminium conductors, with XLPE, longitudinal screen sealing and polyethylene outer sheath

---

For the cable of this mark correspond the foreign-made analogues:

NA2XS2Y (DE) • NA2XS(F)2Y (DE) • A2XS2Y (DE) • A2XS(F)2Y (DE) • Al/XLPE/CWS/MDPE (GB) •  
XUHAKXS (PL) • XHAKXS (PL) • АПвПг (RU) • АПвП (RU)

Technical cable requirements correspond to IEC 60502-2

---

Cables are used for laying:

- *in soil (trenches)*
  - *in the air, including cable structures, if provided the additional fire protection*
- 

It is possible to manufacture cable with a segmented conductor

---

It is possible to manufacture cables with extruded semiconductor layer along outer sheath.

Order entry example:

АПвЭгП-П-20 1x1000/70 ТУ У 31.3-00214534-017-2003

An extruded semiconductor layer along outer sheath ensures the correct testing of cable line with sections of underground laying in polymer pipes.

---

It is possible to manufacture cables with an integrated fiber-optic module.

Order entry example:

АПвЭгП-20 1x1000/70 (OM) ТУ У 31.3-00214534-017-2003

In conjunction with the DTS system, the integrated fiber-optic module can act as a distributed cable line temperature sensor.

---

It is possible to manufacture cable with sealed conductor.

Order entry example:

АПвЭгП-20 1x1000/70 (r) ТУ У 31.3-00214534-017-2003

---



## АПвЭГП-20 1x1000 ТУ У 31.3-00214534-017-2003

Power cables with aluminium conductors, with XLPE, longitudinal screen sealing and polyethylene outer sheath

### TECHNICAL SPECIFICATIONS

Rated voltage	kV	20
Maximum voltage	kV	24
Number and rated area of conductors	mm <sup>2</sup>	1 x 1000
Insulation thickness	mm	5.5
Minimum screen cross-section	mm <sup>2</sup>	70
Permissible short circuit current across the screen of minimum cross-section	kA	14.2
Maximum permissible short-circuit current in core	kA	94
Permissible continuous current rating *		
• by aerial laying in trefoil formation	A	1214
• by aerial flat laying	A	1315
• by burial in trefoil formation	A	736
• by burial flat	A	717
Partial discharge factor for rated voltage, not more than	pC	6
Maximum permissible conductor temperature		
• Continuous	°C	+90
• in emergency operation	°C	+130
• at short circuit	°C	+250
Operating temperature range	°C	-60 ... +50
Minimum bending radius by laying	mm	1008
Rated outer diameter of the cable (for reference) **	mm	63
Cable weight (approximate)	kg/km	4770
Rated factory cable length and gross weight of the delivery on the drums	m, t	# 22УД-60: 450 • 3.1 # 25УД-90: 771 • 5.2

#### Notes:

When ordering it is necessary to agree the factory length of the product with the manufacturer

\* Long permissible current loads are calculated for the following conditions: conductor temperature 90 °C, air temperature 30 °C, soil temperature 20 °C, thermal resistivity of soil 1.5 °K·m/W, laying depth in the soil 0.8 m, while laying in flat formation the distance between cables in clear is equal to the cable diameter, while laying in trefoil formation cables are laid side by side, shields are earthed on both ends of the line

\*\* The external diameter may differ from the rated up to ± 10 %



## АПвЭГП-20 1x1000 ТУ У 31.3-00214534-017-2003

Power cables with aluminium conductors, with XLPE, longitudinal screen sealing and polyethylene outer sheath

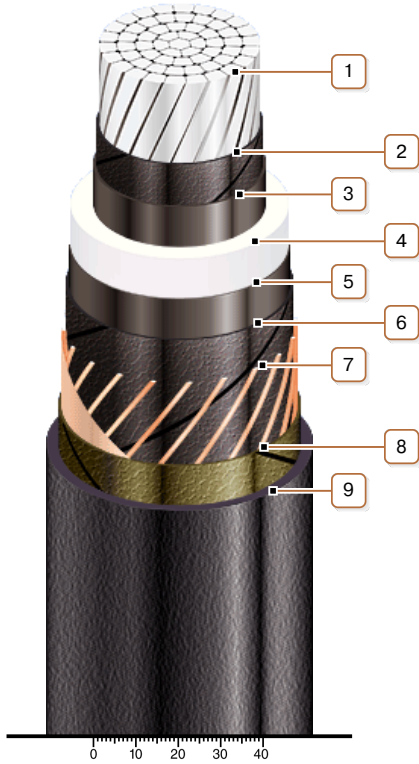

### CONSTRUCTION

#### 1. Aluminium multiwire compacted conductor

Notes:

- It is possible to manufacture cable with a segmented conductor
- It is possible to manufacture cable with sealed conductor.

#### 2. Lapping layer of semiconductive swellable tape

#### 3. Inner extruded semiconducting layer

#### 4. XLPE insulation

#### 5. Outer extruded semiconducting layer

#### 6. Lapping layer of semiconductive swellable tape

#### 7. Copper screen

#### 8. Lapping layer of nonwoven cloth tape

#### 9. Outer sheath of polyethylene or polyethylene copolymer

Note: It is possible to manufacture cable with extruded semiconductor layer along outer sheath