



АПВЭВнг-10 1x70 ТУ У 31.3-00214534-017-2003

Power cables with aluminium conductors, flame-retardant, with XLPE and PVC compound outer sheath

For the cable of this mark correspond the foreign-made analogues:

АПВВнг(В) (RU) • АПВВнг(А) (RU)

Technical cable requirements correspond to IEC 60502-2

Cables are used for laying:

- *in premises, tunnels, ducts, mines, dry soil and outdoor under shelter*
- *in bunches*

It is possible to manufacture cables with an integrated fiber-optic module.

Order entry example:

АПВЭВнг-10 1x70/16 (ОМ) ТУ У 31.3-00214534-017-2003

In conjunction with the DTS system, the integrated fiber-optic module can act as a distributed cable line temperature sensor.

It is possible to manufacture cable with

Order entry example:

АПВЭВнг-10 1x70/16 (ожк) ТУ У 31.3-00214534-017-2003

It is possible to manufacture cable with sealed conductor.

Order entry example:

АПВЭВнг-10 1x70/16 (г) ТУ У 31.3-00214534-017-2003

It is possible to supply of three stranded single-core cables.

Order entry example:

3хАПВЭВнг-10 1x70/16 ТУ У 31.3-00214534-017-2003

Fire safety code in accordance with ДСТУ 4809:2007: ПБ130000000

Products of this mark meet the requirements:

- *single wire cable flame retardance*
- *bunched cable flame retardance category B*



АПвЭВнг-10 1x70 ТУ У 31.3-00214534-017-2003

Power cables with aluminium conductors, flame-retardant, with XLPE and PVC compound outer sheath

TECHNICAL SPECIFICATIONS

Rated voltage	kV	10
Maximum voltage	kV	12
Number and rated area of conductors	mm ²	1 x 70
Insulation thickness	mm	3.4
Minimum screen cross-section	mm ²	16
Permissible short circuit current across the screen of minimum cross-section	kA	3.3
Maximum permissible short-circuit current in core	kA	6.6
Permissible continuous current rating *		
• by aerial laying in trefoil formation	A	230
• by aerial flat laying	A	278
• by burial in trefoil formation	A	186
• by burial flat	A	192
Partial discharge factor for rated voltage, not more than	pC	6
Maximum permissible conductor temperature		
• Continuous	°C	+90
• in emergency operation	°C	+130
• at short circuit	°C	+250
Operating temperature range (in climate version NF)	°C	-50 ... +50
Operating temperature range (in climate version T)	°C	-25 ... +65
Minimum bending radius by laying	mm	480
Rated outer diameter of the cable (for reference) **	mm	30
Cable weight (approximate)	kg/km	850
Rated factory cable length and gross weight of the delivery on the drums	m, t	# 18УД-40: 1100 • 1.5

Notes:

When ordering it is necessary to agree the factory length of the product with the manufacturer

* Long permissible current loads are calculated for the following conditions: conductor temperature 90 °C, air temperature 30 °C, soil temperature 20 °C, thermal resistivity of soil 1.5 °K·m/W, laying depth in the soil 0.8 m, while laying in flat formation the distance between cables in clear is equal to the cable diameter, while laying in trefoil formation cables are laid side by side, shields are earthed on both ends of the line

** The external diameter may differ from the rated up to ± 10 %

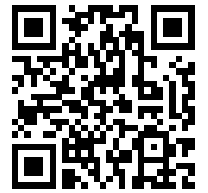

АПвЭВнг-10 1x70 ТУ У 31.3-00214534-017-2003

Power cables with aluminium conductors, flame-retardant, with XLPE and PVC compound outer sheath

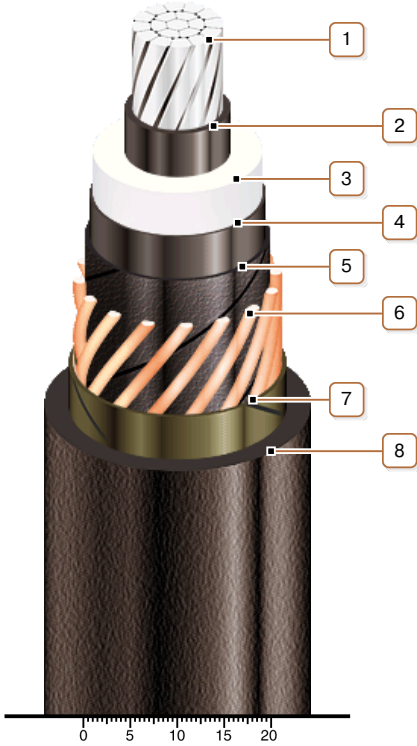

CONSTRUCTION

1. Aluminium multiwire compacted conductor
Note: It is possible to manufacture cable with sealed conductor.
2. Inner extruded semiconducting layer
3. XLPE insulation
4. Outer extruded semiconducting layer
5. Lapping layer of semiconductive swellable tape
6. Copper screen
7. Lapping layer of glass tape
8. Low flammable PVC compound outer sheath