

СБЗПБ6ШВ 4x1 ТУ У 31.3-00214534-008-2001

Signal blocking cables with copper conductors, with polyethylene insulation, with water-blocking core filling, in polyethylene sheath, with galvanized double-steel-tape armouring, in PVC compound hose

Designed for electrical installations of railway signaling, centralization, blocking and automation at a rated voltage of 380 V AC at frequency 50 Hz or 700 V DC

Cables are used for laying:

- *in ducts, tunnels, collectors, in soil (trenches), in corrosive environment*
- *in conditions of excessive humidity*
- *in places, where small mechanical impacts on cable are possible, including tensile forces*

Fire safety code in accordance with ДСТУ 4809:2007: ПБ100000000

Products of this mark meet the requirements:

- *single wire cable flame retardance*

TECHNICAL SPECIFICATIONS

Rated voltage	V	380 / 700
Number and rated diameter of conductors	mm	4 x 1
Electrical resistance of the conductor at 20 °C	Ohm/km	23.3
Operating capacity, not more than	nF/km	150.0
Operating temperature range	°C	-50 ... +60
Minimum bending radius by laying	mm	144
Cable outer diameter (for reference only) **	mm	12
Cable weight (approximate)	kg/km	251
Rated factory cable length and gross weight of the delivery on the drums	m, t	# 10: 1650 • 0.5

Notes:

When ordering it is necessary to agree the factory length of the product with the manufacturer

*** The external diameter may differ from the rated up to $\pm 10\%$*



СБЗПБШВ 4x1 ТУ У 31.3-00214534-008-2001

Signal blocking cables with copper conductors, with polyethylene insulation, with water-blocking core filling, in polyethylene sheath, with galvanized double-steel-tape armouring, in PVC compound hose

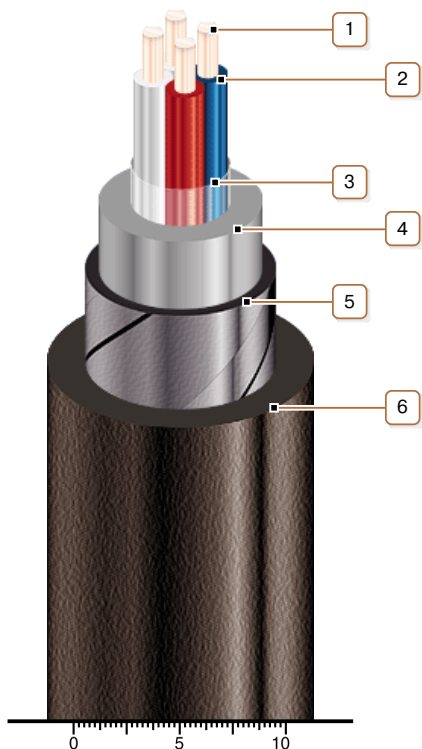

CONSTRUCTION

1. Copper conductor
2. Polyethylene insulation
3. Water-blocking filling
4. Polyethylene inner sheath
5. Double galvanized steel-tape armour
6. PVC compound protection hose

Note: Conductor twisting is not illustrated