

## ВВГзнг 4x35-1 ТУ У 31.3-00214534-018-2003

Power cables with copper conductors, with PVC-compound insulation, with low-flammable PVC-compound outer sheath

Cables are used for laying:

- *in bunches*
- *in premises, dry ducts and tunnels, in corrosive environment*

Manufacturing of cable with multiwire conductors is possible

Fire safety code in accordance with ДСТУ 4809:2007: ПБ120000000

Products of this mark meet the requirements:

- *single wire cable flame retardance*
- *bunched cable flame retardance category A*

### TECHNICAL SPECIFICATIONS

Rated voltage	kV	1
Number and rated area of conductors	mm <sup>2</sup>	4 x 35
Phase insulation thickness	mm	1.2
Permissible continuous current rating (AC of industrial frequency) *		
• <i>by aerial laying</i>	A	127
• <i>by burial</i>	A	146
Maximum permissible conductor temperature		
• <i>Continuous</i>	°C	+70
• <i>in emergency operation</i>	°C	+90
• <i>at short circuit</i>	°C	+160
Operating temperature range	°C	-50 ... +50
Minimum bending radius by laying	mm	217.5
Rated outer diameter of the cable (for reference) **	mm	29
Cable weight (approximate)	kg/km	1890
Rated factory cable length and gross weight of the delivery on the drums	m, t	# 14: 700 • 1.5

Notes:

*When ordering it is necessary to agree the factory length of the product with the manufacturer*

\* Long permissible current loads are calculated during operation in four-wire networks with load in all the conductors for the following conditions: air temperature plus 25 °C, soil temperature plus 15 °C, thermal resistivity of soil 1.2 °K·m/W, laying depth in the soil 0.7 m

\*\* The external diameter may differ from the rated up to ± 10 %



## **ВВГзнг 4x35-1** **ТУ У 31.3-00214534-018-2003**

Power cables with copper conductors, with PVC-compound insulation, with low-flammable PVC-compound outer sheath

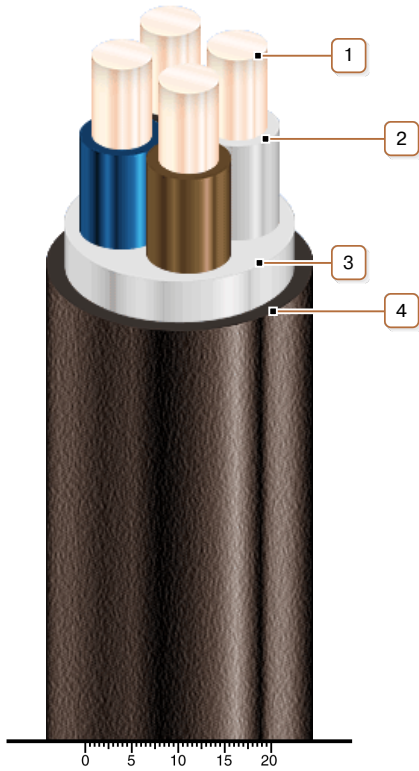

### **CONSTRUCTION**

1. *Copper conductor*
2. *PVC compound insulation*
3. *PVC compound belt insulation*
4. *Low flammable PVC compound outer sheath*

*Note: Conductor twisting is not illustrated*