



## ВБШнг 3x70-6 ТУ У 31.3-00214534-018-2003

Power cables with copper conductors, with PVC-compound insulation, galvanized steel-tape armoured, with low-flammable PVC-compound protection hose

Cables are used for laying:

- *in bunches*
- *in premises, dry ducts and tunnels, in corrosive environment*
- *in places, where small mechanical impacts on cable are possible, including tensile forces*

Fire safety code in accordance with ДСТУ 4809:2007: ПБ120000000

Products of this mark meet the requirements:

- *single wire cable flame retardance*
- *bunched cable flame retardance category A*

### TECHNICAL SPECIFICATIONS

Rated voltage	kV	6
Number and rated area of conductors	mm <sup>2</sup>	3 x 70
Phase insulation thickness	mm	3.4
Permissible continuous current rating (AC of industrial frequency) *		
• <i>by aerial laying</i>	A	211
• <i>by burial</i>	A	231
Maximum permissible conductor temperature		
• <i>Continuous</i>	°C	+70
• <i>in emergency operation</i>	°C	+90
• <i>at short circuit</i>	°C	+160
Operating temperature range	°C	-50 ... +50
Minimum bending radius by laying	mm	375
Rated outer diameter of the cable (for reference) **	mm	50
Cable weight (approximate)	kg/km	4230
Rated factory cable length and gross weight of the delivery on the drums	m, t	# 18: 460 • 2.4 # 20: 740 • 3.8

Notes:

*When ordering it is necessary to agree the factory length of the product with the manufacturer*

\* Long permissible current loads are calculated for the following conditions: air temperature plus 25 °C, soil temperature plus 15 °C, thermal resistivity of soil 1.2 °K·m/W, laying depth in the soil 0.7 m

\*\* The external diameter may differ from the rated up to ± 10 %



## **ВБШнг 3x70-6 ТУ У 31.3-00214534-018-2003**

Power cables with copper conductors, with PVC-compound insulation, galvanized steel-tape armoured, with low-flammable PVC-compound protection hose

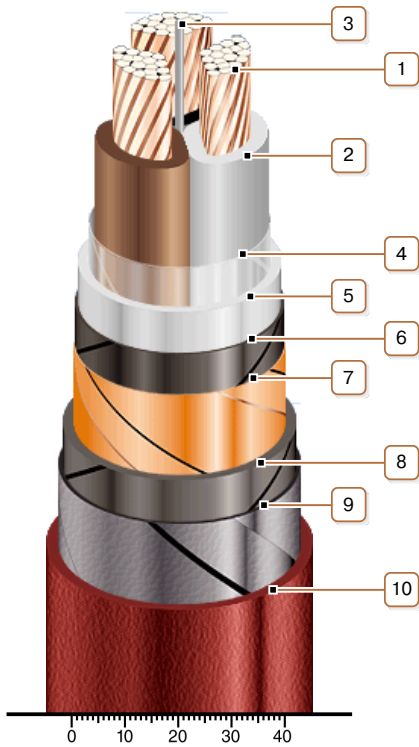

### **CONSTRUCTION**

1. Copper multiwire compact conductor
2. PVC compound insulation
3. PVC compound bundle
4. PET film winding
5. PVC compound belt insulation
6. Lapping layer of semiconductive paper
7. Copper screen
8. Tape bedding
9. Double galvanized steel-tape armour
10. Pressed off low-flammable PVC compound protection hose

Note: Conductor twisting is not illustrated