



СБ2л 4x120-1 ТУ У 27.3-00214534-091:2017

Power cables with copper conductors, with impregnated paper insulation, lead-sheathed, steel-tape armoured

Cables are used for laying:

- *in soil (trenches) with high corrosiveness, as well as with vagabond currents*
- *with a risk of mechanical damage and no tensile forces in operation*

TECHNICAL SPECIFICATIONS

Rated voltage	kV	1
Number and rated area of conductors	mm ²	4 x 120
Insulation thickness between conductors	mm	1.7
Insulation thickness of conductor-sheath	mm	1.45
Sheath thickness	mm	1.46
Permissible continuous current rating *		
• <i>by aerial laying</i>	A	324
• <i>by burial</i>	A	302
Operating temperature range	°C	-50 ... +50
Minimum bending radius by laying	mm	705
Level difference along the laying rout, not more than	m	20
Metal sheath outer diameter (for reference only)	mm	36
Rated outer diameter of the cable (for reference) **	mm	47
Cable weight (approximate)	kg/km	7780
Rated factory cable length and gross weight of the delivery on the drums	m, t	# 16a: 440 • 3.7 # 18: 500 • 4.3

Notes:

When ordering it is necessary to agree the factory length of the product with the manufacturer

* *Long permissible current loads are calculated during operation in four-wire networks with load in all the conductors for the following conditions: air temperature plus 25 °C, soil temperature plus 15 °C, thermal resistivity of soil 1.2 °K·m/W, laying depth in the soil 0.7 m*

** *The external diameter may differ from the rated up to ± 10 %*



СБ2л 4x120-1 ТУ У 27.3-00214534-091:2017

Power cables with copper conductors, with impregnated paper insulation, lead-sheathed, steel-tape armoured

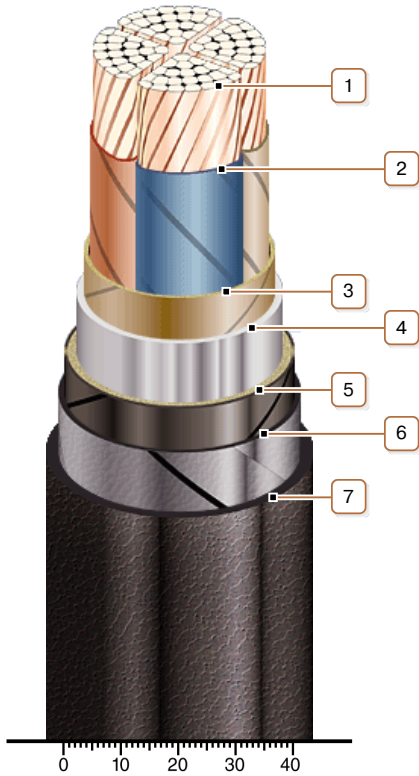

CONSTRUCTION

1. Copper multiwire compact conductor
2. Impregnated paper insulation
3. Belt insulation
4. Lead sheath
5. Double-layer plastic-tape bedding
6. Double steel-tape armour
7. Outer covering

Note: Conductor twisting is not illustrated