

АСБлГ 1x240-3 ТУ У 27.3-00214534-091:2017

Power cables with aluminium conductors, with impregnated paper insulation, lead-sheathed, steel-tape armoured

Cables are used for laying:

- in dry premises (tunnels), ducts, cable cellars, mines, collectors, industrial and other premises, including damp, partially flooded premises, environment with medium and high corrosiveness
- in fire-risk premises
- on technological trestles
- on special cable bridges
- with a risk of mechanical damage and no tensile forces in operation

Fire safety code in accordance with ДСТУ 4809:2007: ПБ100000000

Products of this mark meet the requirements:

- single wire cable flame retardance

TECHNICAL SPECIFICATIONS

Rated voltage	kV	3
Number and rated area of conductors	mm ²	1 x 240
Insulation thickness of conductor-sheath	mm	2.1
Sheath thickness	mm	1.21
Permissible continuous direct current rating *		
• by aerial laying	A	604
• by burial	A	496
Operating temperature range	°C	-50 ... +50
Minimum bending radius by laying	mm	775
Level difference along the laying rout, not more than	m	25
Metal sheath outer diameter (for reference only)	mm	25
Rated outer diameter of the cable (for reference) **	mm	31
Cable weight (approximate)	kg/km	2420
Rated factory cable length and gross weight of the delivery on the drums	m, t	# 16: 370 • 1.2

Notes:

When ordering it is necessary to agree the factory length of the product with the manufacturer

* Long permissible current loads are calculated for the following conditions: air temperature plus 25 °C, soil temperature plus 15 °C, thermal resistivity of soil 1.2 °K·m/W, laying depth in the soil 0.7 m

** The external diameter may differ from the rated up to ± 10 %

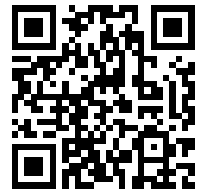

АСБлГ 1х240-3 ТУ У 27.3-00214534-091:2017

Power cables with aluminium conductors, with impregnated paper insulation, lead-sheathed, steel-tape armoured

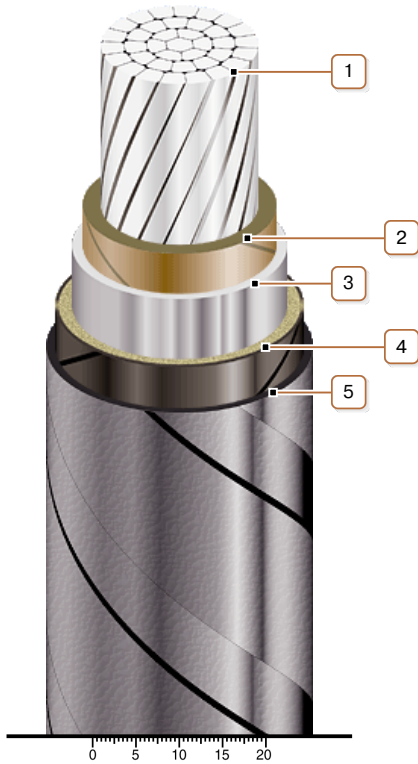

CONSTRUCTION

1. Aluminium multiwire compacted conductor
2. Impregnated paper insulation
3. Lead sheath
4. Single-layer plastic-tape bedding
5. Double galvanized steel-tape armour