



АПвСПу-45 1x120 **ТУ У 31.3-00214534-060:2011**

Power cables with aluminium conductor, XLPE-insulated, lead-sheathed, with reinforced outer sheath of polyethylene

Technical cable requirements correspond to IEC 60840

Cables are used for laying:

- *in places, where small mechanical impacts on cable are possible, including tensile forces*
- *in soil (trenches) with high corrosiveness*
- *in damp, partially flooded premises*
- *in wetlands*
- *in non-navigable waters*
- *on difficult route sections, according to the unique specification*
- *in the air, including cable structures, if provided the additional fire protection*

It is possible to manufacture cables with extruded semiconductor layer along outer sheath.

Order entry example:

АПвСПу-П-45 1x120/95 ТУ У 31.3-00214534-060:2011

An extruded semiconductor layer along outer sheath ensures the correct testing of cable line with sections of underground laying in polymer pipes.

It is possible to manufacture cables with an integrated fiber-optic module.

Order entry example:

АПвСПу-45 1x120/95 (OM) ТУ У 31.3-00214534-060:2011

In conjunction with the DTS system, the integrated fiber-optic module can act as a distributed cable line temperature sensor.

It is possible to manufacture cable with sealed conductor.

Order entry example:

АПвСПу-45 1x120/95 (r) ТУ У 31.3-00214534-060:2011

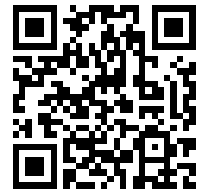

АПвСПу-45 1x120 ТУ У 31.3-00214534-060:2011

Power cables with aluminium conductor, XLPE-insulated, lead-sheathed, with reinforced outer sheath of polyethylene

TECHNICAL SPECIFICATIONS

Rated voltage	kV	45
Maximum voltage	kV	52
Conductor rated area	mm ²	120
Sheath thickness	mm	1.9
Partial discharge factor for rated voltage, not more than	pC	6
Permissible short circuit current across the screen	kA	6.90
Maximum permissible short-circuit current in core	kA	11.3
Permissible continuous current rating by aerial laying *		
• in trefoil formation with double-side screen earthing	A	317
• in trefoil formation with single-side screen earthing or cross screen earthing	A	321
• plane with double-side screen earthing	A	363
• plane with single-side screen earthing or cross screen earthing	A	381
Permissible continuous current rating by burial *		
• in trefoil formation with double-side screen earthing	A	271
• in trefoil formation with single-side screen earthing or cross screen earthing	A	276
• plane with double-side screen earthing	A	273
• plane with single-side screen earthing or cross screen earthing	A	287
Maximum permissible conductor temperature		
• Continuous	°C	+90
• in emergency operation	°C	+130
• at short circuit	°C	+250
Operating temperature range	°C	-60 ... +50
Minimum bending radius by laying	mm	1275
Rated outer diameter of the cable (for reference) **	mm	51
Cable weight (approximate)	kg/km	5250
Rated factory cable length and gross weight of the delivery on the drums	m, t	# 22УД-60: 661 • 4.4 # 25УД-90: 1108 • 7.4

Notes:

When ordering it is necessary to agree the factory length of the product with the manufacturer

* Long permissible current loads are calculated for the following conditions: conductor temperature 90 °C, air temperature 30 °C, soil temperature 20 °C, load factor 1.0, thermal resistivity of soil 1.0 °K·m/W, laying depth in the ground 1.5 m, while laying in flat formation the distance between cables in clear is equal to the cable diameter, while laying in trefoil formation cables are laid side by side

** The external diameter may differ from the rated up to ± 10 %



АПвСПу-45 1x120 ТУ У 31.3-00214534-060:2011

Power cables with aluminium conductor, XLPE-insulated, lead-sheathed, with reinforced outer sheath of polyethylene

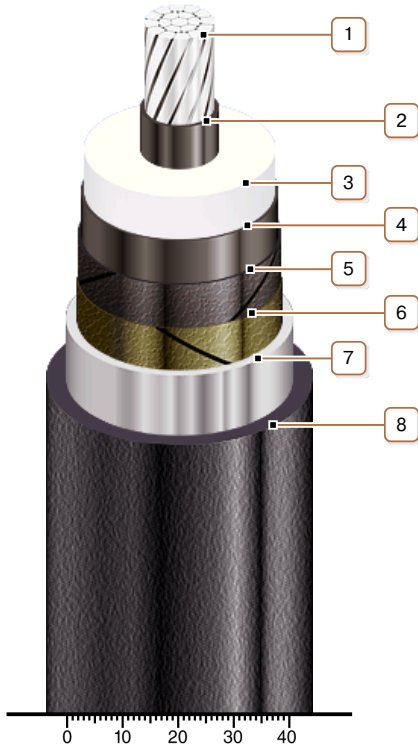

CONSTRUCTION

1. Aluminium multiwire compacted conductor

Note: It is possible to manufacture cable with sealed conductor.

2. Inner extruded semiconducting layer

3. XLPE insulation

4. Outer extruded semiconducting layer

5. Lapping layer of semiconductive swellable tape

6. Lapping layer of semiconductive tape

7. Lead sheath

8. Strengthened polyethylene outer sheath

Note: It is possible to manufacture cable with extruded semiconductor layer along outer sheath